



QUICK START INSTRUCTIONS



QUEST DUAL 165 / 225

READ AND SAVE THESE INSTRUCTIONS.

For a complete manual, go to www.questclimate.com/manuals

This manual is provided to acquaint you with the dehumidifier so that installation, operation and maintenance can proceed successfully. Ultimate satisfaction depends on the quality of installation and a thorough understanding of this equipment. The dehumidifier is built around tested engineering principles and has passed a thorough inspection for quality of workmanship and function.

(877) 420-1330
QUESTCLIMATE.COM
TS-1096 03/19 REV. B

ASSEMBLY & INSTALLATION

Thanks for purchasing a Quest Dual dehumidifier. For a complete manual, visit www.questclimate.com/manuals. Please follow these steps to successfully assemble and install your new dehumidifier.

1 UNPACK BOX.

2 REGISTER WARRANTY AT THERMASTOR.COM/REGISTRATION

3 CHECK THAT YOU HAVE ALL PARTS:

- A. DEHUMIDIFIER (1)
- B. FEET (4)
- C. COMPRESSOR PLUGS (2)
- D. DRAIN HOSE (1)
- E. DRAIN ADAPTER (1)
3/4" NPT PVC TO 5/8" HOSE BARB

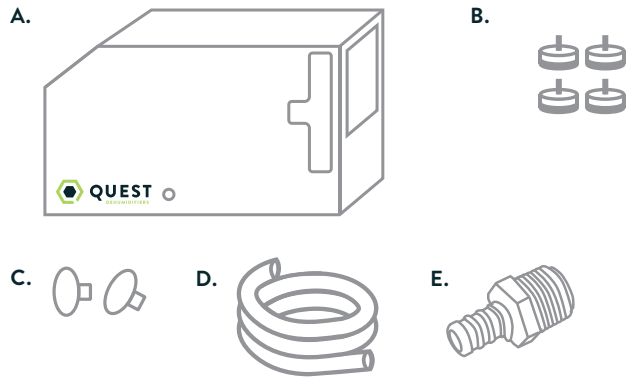

QUEST DUAL DEHUMIDIFIERS CAN RUN WITHOUT ADDITIONAL ACCESSORIES. DEPENDING ON INSTALLATION, YOU MAY REQUIRE ADDITIONAL PARTS. SEE STEP 14 FOR ADDITIONAL INFORMATION

4 READ ALL REMAINING STEPS AND WARNINGS BEFORE CONTINUING.

5 CUT AND REMOVE SHIPPING ZIP TIE, INSERT COMPRESSOR PLUGS.

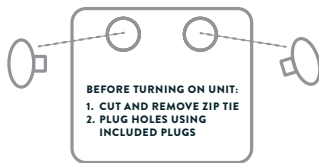

6 DECIDE WHERE TO PLACE UNIT IN GROW ROOM.

⚠ WARNING! DON'T BLOCK AIRFLOW INLET. OUTLET MUST BE AT LEAST 12 INCHES FROM WALLS AND OTHER OBSTRUCTIONS.

7 CHOOSE WHETHER TO PLACE ON FLOOR OR HANG DEHUMIDIFIER.

A. IF YOU PLACE ON FLOOR, ATTACH LEVELING FEET.



B. IF YOU HANG DEHUMIDIFIER, USE 2 BRACKETS* PER UNIT. * BRACKETS SOLD SEPARATELY.



HERE IS ONE WAY TO HANG YOUR DEHUMIDIFIER:

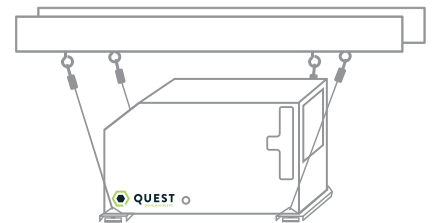

* RECOMMEND 4" OFF GROUND
SEE MANUAL FOR MORE DETAILS

C. IF YOU PLACE THE DEHUMIDIFIER OUTSIDE THE GROW ROOM, SEE SECTION 13 ON THE FOLLOWING PAGE.

8 INSERT DRAIN ADAPTER AND ATTACH DRAIN HOSE* TO UNIT.

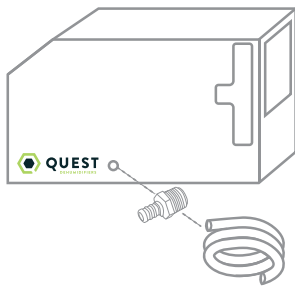

*YOU CAN USE PROVIDED HOSE, OR INSTALL PVC TO ROUTE WATER.

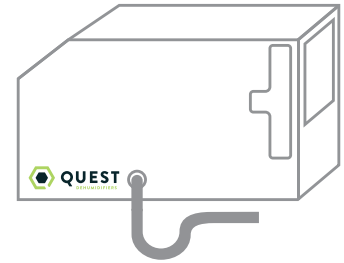

9 OUTPUT TO DRAIN OR BUCKET.

- A. ATTACH A P-TRAP (AVAILABLE AT MOST HARDWARE STORES.)
- B. IF YOU NEED WATER TO TRAVEL A FURTHER DISTANCE, SEE SECTION 13 BELOW ON HOW TO ORDER A PUMP KIT.
- C. SEE MANUAL FOR MORE DETAILS.



10 VERIFY WALL OUTLET IS CORRECT VOLTAGE AND AMPERAGE.

11 PLUG IN UNIT.

Specifications @ 80°F AND 60%RH		
UNIT	165 DUAL 4037410	225 DUAL 4035400
Blower	391 CFM @ 0.0"WG	526 CFM @ 0.0"WG
Supply Voltage (VAC)	220-240	220-240
Current Draw (Amps)	4.1	6.9
Operating Temperature	56°F - 95°F	56°F - 95°F
Air Filter (MERV-11)	Size: 16"x20"x2"	Size: 16"x20"x2"
Weight (lbs)	140	160
Capacity (Pints/Day)	165	225
Efficiency (Pints/kWh)	6.8	6.1
Power Cord	 14ga 10', NEMA 6-15P	 14ga 10', NEMA 6-15P

* Requires buck/boost transformer to run on 208V or 277V

12 ADJUST HUMIDITY.

*PLACE SWITCH TO DEHUMIDISTAT MODE.

- A. TURN ONBOARD KNOB TO DESIRED SETTING.

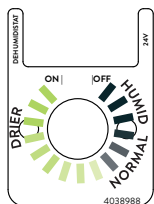

- B. IF YOU PREFER EXTERNAL CONTROLS, SEE SECTION 13 BELOW ON HOW TO ORDER.

REMINDER: PLACE SWITCH TO 24V MODE.

QUEST DEH 3000R CONTROL WIRING DIAGRAM

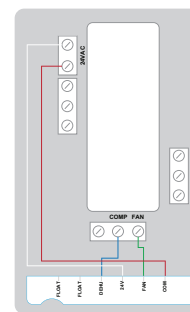

HONEYWELL REMOTE HUMIDISTAT WIRING DIAGRAM

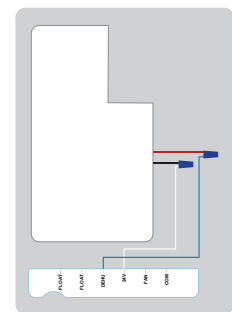

13 ACCESSORIES

TO PURCHASE ADDITIONAL ACCESSORIES FOR YOUR SYSTEM, VISIT QUESTHYDRO.COM/PRODUCT-CATEGORY/ACCESSORIES

- A. **REPLACEMENT FILTER:** Change filters each grow cycle for maximum performance.
- B. **BRACKETS:** Recommended for hanging the dehumidifier overhead.
- C. **PUMP KIT:** Allows for draining and transferring water when the unit is not hard plumbed or near a drain.
- D. **DUCT KIT:** Direct airflow when placing the dehumidifier outside of your grow room.
- E. **EXTERNAL CONTROL:** Ideal for overhead installation or with duct work.

QUEST DUAL DEHUMIDIFIER LIMITED WARRANTY

WARRANTOR

THERMA-STOR LLC
4201 LIEN RD., MADISON, WI 53704
1-800-533-7533

WHO IS COVERED

This warranty extends only to the original end-user of the Quest Dual dehumidifier, and may not be assigned or transferred.

FIRST YEAR WARRANTY

Therma-Stor LLC warrants that for one (1) year the Quest Dual dehumidifier will operate free from any defects in materials and workmanship, or Therma-Stor LLC will, at its option, repair or replace the defective part(s), free of any charge.

SECOND THROUGH FIFTH YEAR WARRANTY

Therma-Stor LLC further warrants that for a period of five (5) years, the condenser, evaporator and compressor of the Quest Dual dehumidifier will operate free of any defects in material or workmanship, or Therma-Stor LLC, at its option, will repair or replace the defective part(s), provided that all labor and transportation charges for the part(s) shall be borne by the end-user.

END-USER RESPONSIBILITIES

Warranty service must be performed by a Servicer authorized by Therma-Stor LLC. If the end-user is unable to locate or obtain warranty service from an authorized Servicer, he should call Therma-Stor LLC at the above number and ask for the Therma-Stor LLC Service Department, which will then arrange for covered warranty service. Warranty service will be performed during normal working hours.

The end-user must present proof of purchase (lease) upon request, by use of the warranty card or other reasonable and reliable means. The end-user is responsible for normal care. This warranty does not cover any defect, malfunction, etc., resulting from misuse, abuse, lack of normal care, corrosion, freezing, tampering, modification, unauthorized or improper repair or installation, accident, acts of nature or any other cause beyond Therma-Stor LLC's reasonable control.

LIMITATIONS AND EXCLUSIONS

If any Quest Dual Dehumidifier part is repaired or replaced, the new part shall be warranted for only the remainder of the original warranty period applicable thereto (but all warranty periods will be extended by the period of time, if any, that the Quest Dual Dehumidifier is out of service while awaiting covered warranty service).

UPON THE EXPIRATION OF THE WRITTEN WARRANTY APPLICABLE TO THE QUEST DUAL DEHUMIDIFIER OR ANY PART THEREOF, ALL OTHER WARRANTIES IMPLIED BY LAW, INCLUDING MERCHANTABILITY AND FITNESS FOR A PARTICULAR PURPOSE, SHALL ALSO EXPIRE. ALL WARRANTIES MADE BY THERMA-STOR LLC ARE SET FORTH HEREIN, AND NO CLAIM MAY BE MADE AGAINST THERMA-STOR LLC BASED ON ANY ORAL WARRANTY. IN NO EVENT SHALL THERMA-STOR LLC, IN CONNECTION WITH THE SALE, INSTALLATION, USE, REPAIR OR REPLACEMENT OF ANY QUEST DUAL DEHUMIDIFIER OR PART THEREOF BE LIABLE UNDER ANY LEGAL THEORY FOR ANY SPECIAL, INDIRECT OR CONSEQUENTIAL DAMAGES INCLUDING WITHOUT LIMITATION WATER DAMAGE (THE END-USER SHOULD TAKE PRECAUTIONS AGAINST SAME), LOST PROFITS, DELAY OR LOSS OF USE OR DAMAGE TO ANY REAL OR PERSONAL PROPERTY. SOME STATES DO NOT ALLOW LIMITATIONS ON HOW LONG AN IMPLIED WARRANTY LASTS, AND SOME DO NOT ALLOW THE EXCLUSION OR LIMITATION OF INCIDENTAL OR CONSEQUENTIAL DAMAGES, SO ONE OR BOTH OF THESE LIMITATIONS MAY NOT APPLY TO YOU.

LEGAL RIGHTS

This warranty gives you specific legal rights, and you may also have other rights which vary from state to state.

READ AND SAVE THESE INSTRUCTIONS

- The device is designed to be installed INDOORS IN A SPACE THAT IS PROTECTED FROM RAIN AND FLOODING.
- Install the unit with space to access the back or side panels for maintenance and service. DO NOT INSTALL UNIT WITH THE SERVICE PANELS INACCESSIBLE.
- Avoid directing the discharge air at people, or over the water in pool areas.
- If used near a pool, spa or water; be certain there is NO chance the unit could fall into the water, be splashed and that it is plugged into an outlet that is a GROUND FAULT INTERRUPT protected circuit.
- DO NOT use the device as a bench or table.
- DO NOT place the device directly on structural members. Provide vibration isolation in order to minimize operational vibration and/or noise.
- A drain pan MUST be placed under the unit if installed above a living area or above an area where water leakage could cause damage
- Never operate a unit with a damaged power cord. If the power cord is damaged it must be replaced by the manufacturer, its service agent, or similarly qualified person in order to avoid a hazard.
- Make all electrical connections in accordance with the current edition of the NEC ANSI/NFPA 70 and any national and local codes or ordinances that may apply
- Do not obstruct the air intake and exhaust. Maintain a .3 m (1 ft) clearance around the air intake and exhaust.
- This appliance is not intended for use by persons (including children) with reduced physical, sensory or mental capabilities, or lack of experience and knowledge, unless they have been given supervision or instruction concerning use of the appliance by a person responsible for their safety. Children should be supervised to ensure that they do not play with the appliance.